

# HERCULES DC

## OWNER'S MANUAL

---

Please read this Owner's Manual carefully before using your **Hercules** Vertical Platform Lift to ensure safe and correct operation. Keep this manual in a safe place for future reference.

**HERCULES DC RESIDENTIAL & COMMERCIAL**

Rev: July 12, 2018  
p/n: 999922-0017

## ■ THANK YOU FOR CHOOSING AMERIGLIDE

Congratulations on purchasing your **HERCULES** Vertical Platform Lift. Before using your lift, please take a moment to read this Owner's Manual carefully to ensure your lift is operated correctly and safely.

The AmeriGlide **HERCULES** Vertical Platform Lift is a compact and powerful lift designed for the harsh North American climates. The **HERCULES** model provides the user with a seamless and safe experience. A series of safety features including; emergency stop buttons, emergency lowering hand-wheel and safety detection sensors offer the peace of mind when operating the lift.

The **HERCULES** Vertical Platform Lift has been designed, developed and manufactured to B-613, B-355 and ASME 18.1 regulation.

More detailed information is readily available by contacting your Authorized AmeriGlide Dealer.

Sincerely,

The AmeriGlide Team

# IMPORTANT INFORMATION

If you have questions or concerns regarding the operation or maintenance of your AmeriGlide **HERCULES** Vertical Platform, please contact your dealer.

## DEALER INFORMATION

DEALER NAME: \_\_\_\_\_

ADDRESS: \_\_\_\_\_

TELEPHONE NUMBER: \_\_\_\_\_

E-MAIL: \_\_\_\_\_

If your lift needs repair or service, your dealer will need the date of purchase and serial number.

## WARRANTY INFORMATION

DATE OF PURCHASE: \_\_\_\_\_

SERIAL NUMBER: \_\_\_\_\_

**Your serial number is found on a sticker located on the side of the lift's tower.**

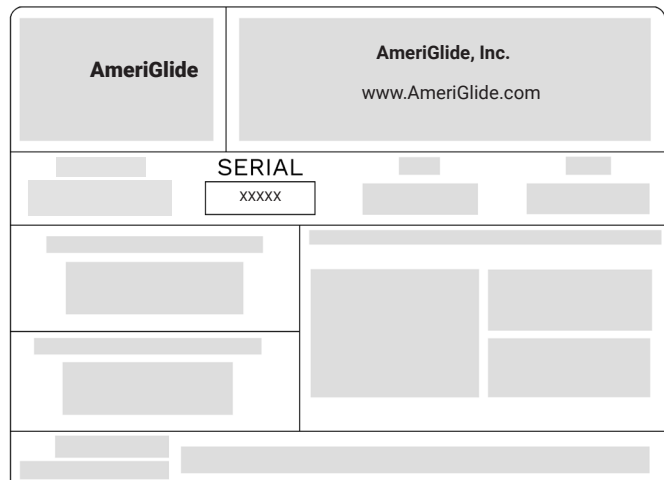

## **SAFETY WARNING**

Read all instructions contained in this Owner's Manual before operating the **HERCULES** Vertical Platform Lift. Proper operation is the responsibility of the operator and failure to follow all instructions could result in unreliable or unsafe operation.

### **PREVENTING SERIOUS INJURY OR DEATH**

Personal safety is our primary concern during all procedures. Before using your lift, please read and understand this Owner's Manual and all containing procedures carefully to ensure correct and safe operation. Remember, the **HERCULES** Vertical Platform Lift must be operated only by a qualified, competent and responsible person. For your safety and others, it is highly advised to know how to obtain emergency medical and fire fighting assistance.

To ensure your **HERCULES** Vertical Platform Lift operates safely, regular maintenance is required. Please refer to the Recommended Maintenance section of this Owner's Manual for more information. Improper use, adjustment, service, or maintenance can cause personal injury or property damage.

**If you have any problems or need assistance please contact your dealer immediately.**

# CONTENTS

THANK YOU FOR CHOOSING AMERIGLIDE .....	2
IMPORTANT INFORMATION .....	3
SAFETY WARNING .....	4
Preventing Serious Injury or Death .....	4
HERCULES VERTICAL PLATFORM LIFT .....	6
Lift Layout .....	6
TECHNICAL FEATURES .....	7
HERCULES FEATURES .....	8
Automatic Gate & Door Opener/Closer (Optional) .....	8
Safety Detection Sensors .....	8
Interlock .....	8
Folding Seat (Optional) .....	8
Wireless Remote (Optional) .....	8
Platform Lighting (optional) .....	8
Anti-Slip surface .....	8
SAFE OPERATION .....	9
Follow these points to ensure safety .....	9
CONTROLS & OPERATION .....	10
Outside the Cabin .....	10
Inside the Cabin .....	11
CARE & TROUBLESHOOTING .....	13
Care and Cleaning .....	13
Professional Service .....	13
MANUAL OVERRIDE .....	14
Emergency Lowering Hand-Wheel .....	14
Manually Moving the Lift .....	14
BATTERY CHARGER .....	15
Testing Procedure .....	15
RECOMMENDED MAINTENANCE .....	16
Your Responsibilities .....	16
NOTES .....	17

# HERCULES VERTICAL PLATFORM LIFT

## LIFT LAYOUT

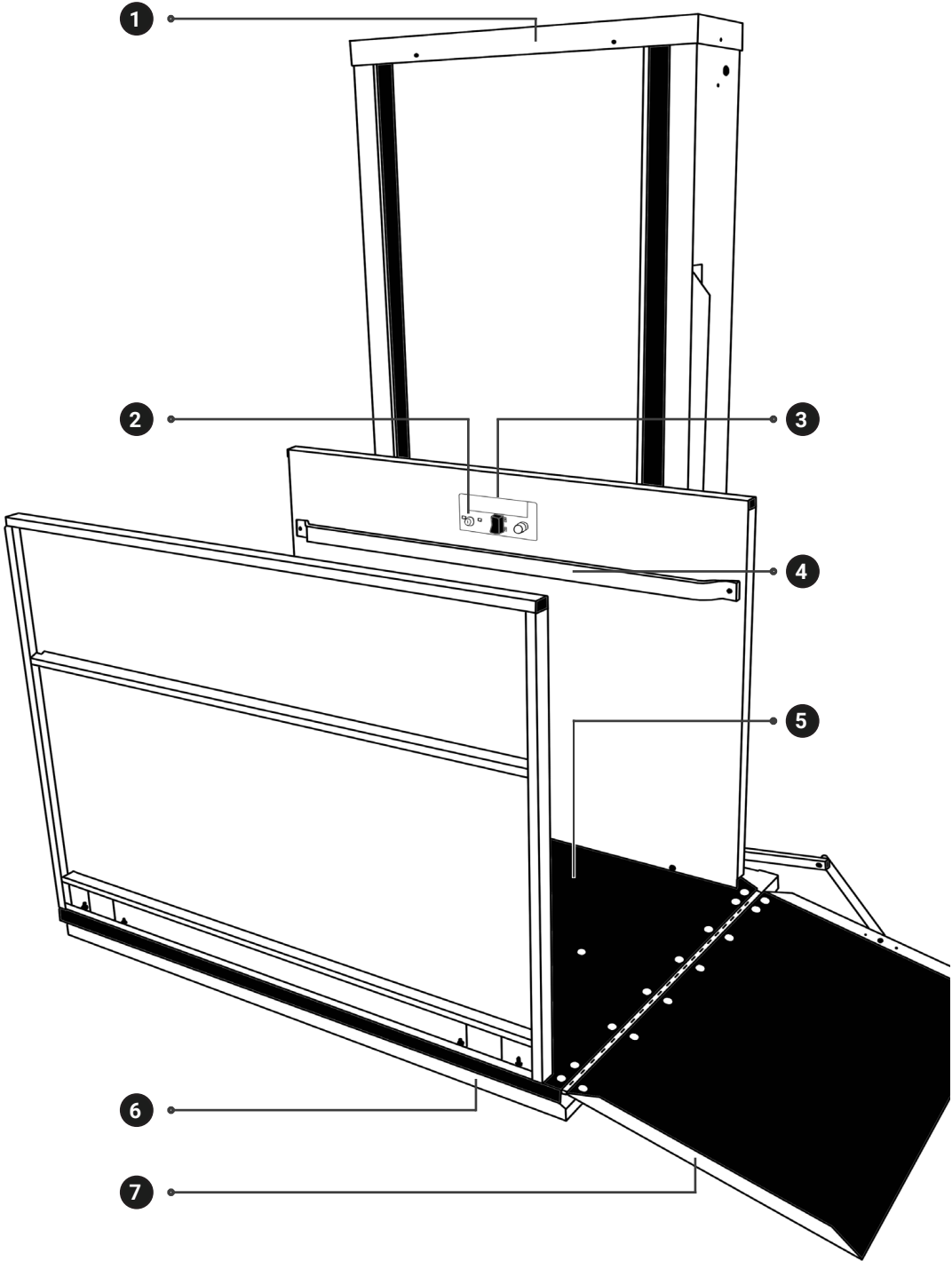

- 1 Tower Top Cover
- 2 Key Switch (OPTIONAL)
- 3 Easy-To-Use Control Panel
- 4 Hand Rail (OPTIONAL)
- 5 Weather Resistant & Anti-Slip Coating
- 6 Safety Detection Sensors
- 7 Automatic Folding Ramp

## TECHNICAL FEATURES

# Learn more about your **HERCULES** lift's technical features

Your AmeriGlide **HERCULES** Vertical Platform Lift is designed and engineered in accordance with current Canadian Standard Association (CSA/B613-00 or CSA/B355-09) and American Society of Mechanical Engineers (ASME 18.1) standards. The rugged design is ideal for indoor and outdoor use, enabling you to move from one level to another with peace of mind. The **HERCULES** lift is easy to operate and with low maintenance requirements you can depend on many years of reliable use.

- Load Capacity **750 LBS to 1000 LBS** (340 KG TO 454 KG)
- Maximum Travel **130"** (3.30M)
- Travel Speed **12 FPM** (0.07 M/S)
- Drive Type **ACME SCREW** (DIRECT DRIVE)
- Power Supply **120V 20A 60HZ** (OPTIONAL 120V 15A 60HZ)
- Warranty **12 MONTHS** (LIMITED WARRANTY)
- Codes and Standards **CSA B613, CSA B355 & ASME 18.1**

## HERCULES FEATURES

### **AUTOMATIC GATE & DOOR OPENER/CLOSER (OPTIONAL)**

Your lift comes standard with manual door closers. Individual landings can be supplied with **Automatic Gate & Door Opener/Closer** that are equipped with safety sensors. If the door/gate meets any obstruction during operation, the door/gate will stop and close. Door opening, closing and unlocking times can be adjusted if required. Please speak to your service technician if it requires adjustment.

### **SAFETY DETECTION SENSORS**

**Safety Detection Sensors** on the underpan of the platform come standard. The sensors detect any obstacles and stop the lift immediately.

### **INTERLOCK**

**Interlocks** on the landings prevent the gate & doors from unlocking while the lift is moving and not at a landing.

### **FOLDING SEAT (OPTIONAL)**

If opted for, your lift is equipped with a **Folding Seat** that provides seating for one person during lift travel. When not in use, it can be folded away and secured to the cabin wall.

### **WIRELESS REMOTE (OPTIONAL)**

The **Wireless Remote** is used to operate the Door Opener with ease without having to use the Call Stations.

### **PLATFORM LIGHTING (OPTIONAL)**

**Platform Lighting** offers a safe and comfortable operating environment. They are ideal for dimly lit settings and those with limited vision.

### **ANTI-SLIP SURFACE**

Your lift comes standard with an **Anti-Slip Surface**, improving safety while entering and exiting the cabin.



## SAFE OPERATION



### FOLLOW THESE POINTS TO ENSURE SAFETY

- Only a competent and mature person, who understands proper operation of the lift should operate the lift.
- Keep clear of moving parts at all time.
- Ensure your weight is centered and distributed evenly on the platform before operating the lift.
- Make sure all landing areas are clear before ascending or descending the lift.
- Ensure that all doors and gates are locked and secure before operating the lift.
- Only one person (or one person and an assistant) should ever use the lift at any time.
- Never use the lift when the Emergency Lowering Hand-Wheel in position.
- Never allow unsupervised children to use the lift.
- Never attempt to service or repair the lift yourself.
- In the unlikely event that your lift stops working, do NOT exit or attempt to exit your lift. Instead, press the alarm button on the control panel to signal for help.
- Ensure proper regular maintenance.

# CONTROLS & OPERATION

## OUTSIDE THE CABIN

### OPERATION FROM LANDING

- Upon arriving to the lift you will find the landing Call Station. The Call Station may vary or differ from the picture below (Fig 1).
- Insert your key into the Key Switch (if equipped) and turn the key to the “ON” position.
- When the Call Button is pressed the gate will unlock if the lift is on the same level, allowing you to open the gate and enter the lift.
- If the lift is on a different level, the button will need to be held until the lift arrives to the same level and comes to a complete stop. When the lift arrives, the gate will unlock allowing you to open the gate and enter the lift.

### KEY SWITCH OPERATION (OPTIONAL)

- The Call Station has a Key Switch feature that allows the user to isolate the Call Station and prevent unauthorized operation.
- Turn the key to the “ON” position to enabled the Call Station. Allow a few seconds for the Call Station to reset.
- When the key is in the “OFF” position, the Call Station is isolated and will not function.

Fig 1. 2 BUTTON CALL STATION - 455 KEY TYPE

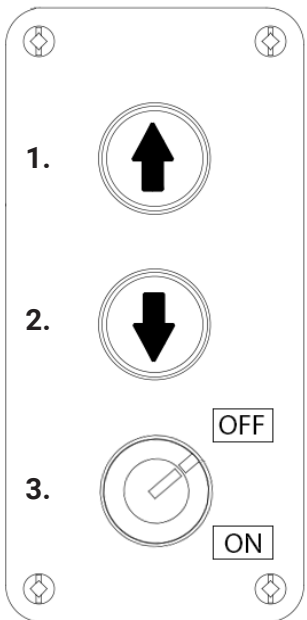

### LANDING CALL STATION

#### 1. “UP”

Press the up arrow to call the platform to the Upper Landing.

#### 2. “DOWN”

Press the down arrow to call the platform to the Lower Landing.

#### 3. Key Switch (OPTIONAL)

Turning the Key Switch to “OFF” will isolate the Call Station, rendering the Call Station unusable while isolated.

Turning the Key Switch to “ON” initiates the Call Station, making the Call Station operational.

# CONTROLS & OPERATION

## INSIDE THE CABIN

### CABIN CONTROL PANEL

Fig 2. CABIN CALL STATION WITH KEY SWITCH

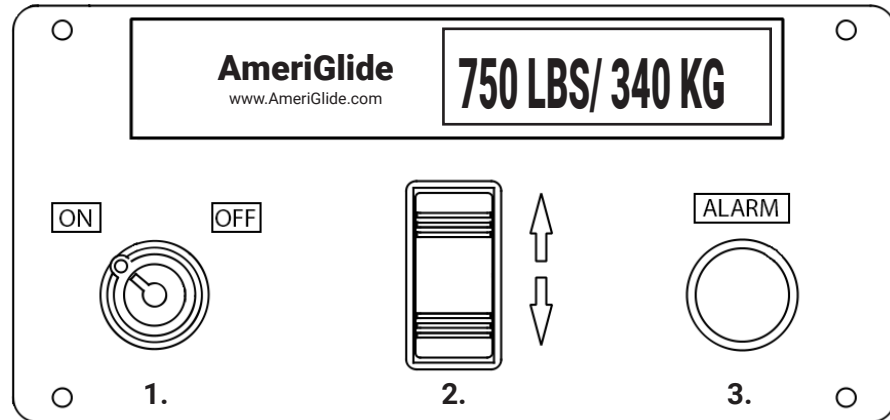

#### 1. Key Switch (OPTIONAL)

Please refer to the Key Switch Operation on the previous page for more information.

#### 2. Continuous Directional Rocker Switch

Press and hold "UP" on the Continuous Directional Rocker Switch to ascend to the Upper Landing. Conversely, press and hold "DOWN" on the Continuous Directional Rocker Switch to descend to the Lower Landing.

#### 3. Alarm Button

In the event of a problem or difficulty, help can be reached by continuously pressing the alarm button.

### OPERATION FROM THE CABIN

- Upon entering the lift you will find the Cabin Control Panel. The Cabin Control Panel may vary or differ from the above picture (Fig 2).
- Insert your key into the Key Switch (if equipped) and turn the key to the "ON" position.
- When the lift gate is closed and locked, press the Continuous Directional Rocker Switch to travel to the desired landing.
- During travel, be mindful of the moving parts around you and ensure that you and other passengers are away from the sides of the moving cabin.
- Upon reaching the desired level, the door will unlock and you may safely exit the lift.

# CONTROLS & OPERATION

## INSIDE THE CABIN

### FOLDING SEAT (OPTIONAL)

Fig 3. FOLDING SEAT IN TRAVEL POSITION

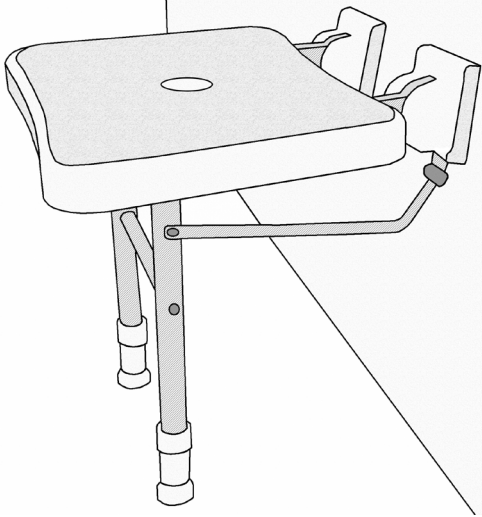

- To use, fold out the seat and legs. Ensure the seat's legs have fully extended into position.
- Ensure that you are seated with feet firmly on the platform before operating the lift.
- Before exiting the lift, ensure the folding seat assembly is folded-up and secured.

### WIRELESS REMOTE (OPTIONAL)

Fig 4. 4 BUTTON WIRELESS REMOTE

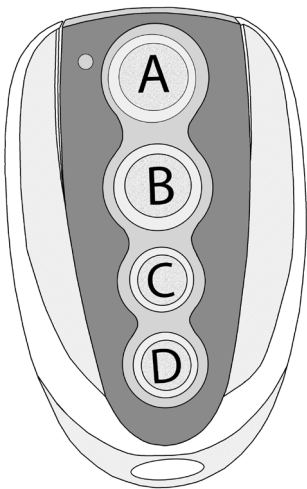

- Your Wireless Remote will arrive programmed.
- Depending on the configuration, pressing the button will automatically open the corresponding gate/door.
- To reprogram your remote please refer to the Door Operator Control Connections Diagram included in your documentation.
- The Remote Control is battery powered. The battery can be replaced by unscrewing the three small screws located on the back of the Remote Control.

# CARE & TROUBLESHOOTING

## CARE AND CLEANING

Following these procedures will help keep your lift in good condition;

- Keep the tower, cabin and landings clean.
- Use a mild cleaner to clean your lift panels and platform.
- DO NOT use abrasive cleaners.

For outdoor and coastal installations, more frequent care and cleaning must be carried out. This includes;

- One full cycle of lift operation.
- Wiping down the lift with a soft cloth by hand (No pressure washing).
- Keeping your lift free of debris (snow, ice, leaves, dirt, etc.)
- Inspection and reporting of any misuse or vandalism to the lift.

## PROFESSIONAL SERVICE

Regular maintenance and having your lift undergo a complete inspection by an Authorized AmeriGlide Dealer is imperative to the longevity of your lift. Refer to the Recommended Maintenance for a full list.

**Having your HERCULES Vertical Platform Lift serviced by anyone other than an authorized AmeriGlide dealer will render your limited warranty null and void.**

## TROUBLESHOOTING

If your lift does not operate, diagnose the problem by checking the following list before contacting your Authorized AmeriGlide Dealer. Doing so can save you time and the cost of an unnecessary service call.

- Ensure that the landing door/gate is closed before operating the lift.
- Check that the building's circuit breaker has not tripped.
- Ensure the Emergency Pit Stop is pulled out.
- Ensure the power cord is plugged in.
- If equipped, turn the Key Switch to "ON" and allow the lift to reset.

**IF AFTER TROUBLESHOOTING THE LIFT WILL STILL NOT RUN, CONTACT YOUR AUTHORIZED AMERIGLIDE DEALER FOR ASSISTANCE.**

# MANUAL OVERRIDE

## BEFORE PROCEEDING

Before proceeding, take a moment to go over the Troubleshooting Checklist found on the previous page. If the checklist does not solve the problem, then follow the instructions below.

## EMERGENCY LOWERING HAND-WHEEL

Fig 5. EMERGENCY LOWERING HAND-WHEEL

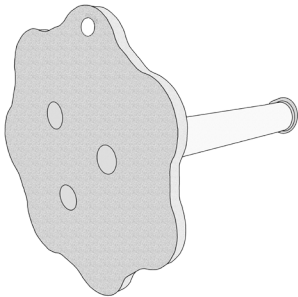

In the unlikely event that your **HERCULES** Vertical Platform Lift stops working while traveling, we have provided you with an Emergency Lowering Hand-Wheel and instructions on how to manually move your lift.

Your Emergency Lowering Hand-Wheel should always be kept in a safe location that is readily accessible. Never operate the lift when the Emergency Lowering Hand-Wheel is in the drive.

## MANUALLY MOVING THE LIFT

1. Disconnect the power.
2. Remove the Tower Top Cover by unscrewing the 4 hex bolts.\*
3. Insert the Emergency Lowering Hand-Wheel into the Drive at the Top Insertion Point.
4. Rotate the Hand-Wheel to move the lift to the nearest landing.
5. Remove the Emergency Lowering Hand-Wheel and put the Tower Top Cover back on. Ensure the Tower Top Cover is well fastened.
6. Call your dealer immediately for an inspection.

Fig 6. TOP COVER REMOVE FROM TOWER

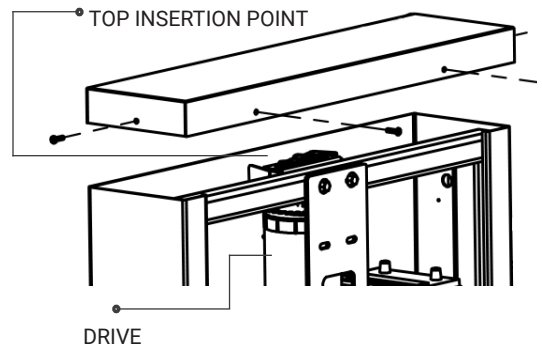
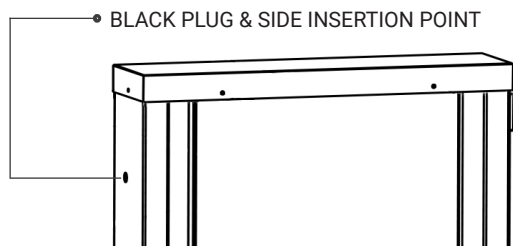

Fig 7. TOP COVER & TOWER



**\* FOR SIDE MOUNTED DRIVES, THE TOWER TOP COVER DOESN'T NEED TO BE REMOVED. INSTEAD, USE A FLAT HEAD SCREW DRIVE TO REMOVE THE BLACK PLUG ON THE SIDE OF THE TOWER AND INSERT THE HAND-WHEEL INTO THE SIDE INSERTION POINT.**

# BATTERY CHARGER

Your **HERCULES** lift is equipped with a Battery Charger (located inside your HERCULES tower) that is responsible for charging two Rechargeable Packs inside your lift's tower.

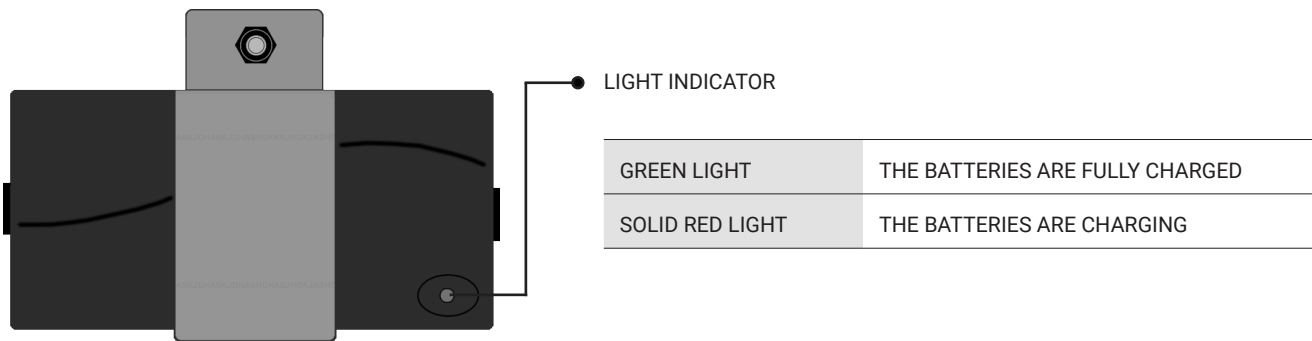

To ensure that your Rechargeable Packs are properly functioning it's highly advised that you regularly test your Battery Charger.

## TESTING PROCEDURE

To test the Battery Charger, follow these steps;

1. Perform 5 platform cycles in order to partially discharge the lift's batteries.
2. Ensure that the Charger is correctly connected to the Batteries.

**RED = Positive (+)**      ■      **BLACK= Negative (-)**

3. Connect an Amp Meter to the RED wire and measure the current.
4. If the current reads above 0.5A then the Charger is functioning properly.
5. If the Charger is functioning properly, recharge the Batteries. The Light Indicator will be green when the Batteries are fully charged.

# RECOMMENDED MAINTENANCE

## YOUR RESPONSIBILITIES

You are responsible for having an AmeriGlide Certified Professional regularly maintain your lift and ensure that the materials used are Genuine AmeriGlide Parts that meet factory engineering standards and specifications. Ensure your Maintenance Control sheet is validated each time a scheduled maintenance service is performed. Failure to perform scheduled maintenance and use AmeriGlide parts as specified by AmeriGlide may jeopardize your warranty coverage.

The following inspections shall be carried-out every **6 months**;

### CONTROLLER

- Run the Protection in Case of Failure test in the Acceptance Test Drawing D2.
- Check power contactor contacts cleanliness, terminal tightening.
- Fuse, Fuse Holder, Breaker.
- Cover is present over the controller enclosure.
- Protection in Case of Failure.

### DRIVE SCREW

- Screw thread external major diameter is over 0.990".
- Screw-thread thickness using an ACME thread gauge.
- Remove contaminant from screw thread using a light solvent.
- Add Shell Gadus V220 grease on the screw thread for indoor units. Molykote 33 for outdoor units.
- CO Switch
- FO Switch
- Backup Nut, compression springs between main nut and Backup Nut.

### LANDINGS

- Interlock beak is aligned with interlock opening.
- Doors are flush
- Landing light is present and functional
- Landing doors cannot be opened from landing with the use of common tools.

### BOGIE

- Guide Wheels.
- Wheel Axles.
- Carriage to Upright 3/8"-16 Bolts.
- Any noise or squeaking of the wheels.

### CABIN

- Commands, key switch, E-stop, Cabin lights, Alarm.
- Access Ramp and folding mechanism.
- Underpan, Underpan Switches.
- Folding Seat.

### RUNWAY

- Pit Emergency-Stop
- Pit light switch, light and GFCI outlet.
- Limit switches LS and DZ. Check for proper alignment, position, actuating cam.
- Position of the Cab at various landings.
- Mechanical final limits max 50mm over travel (top and bottom) (position and tightening torque).
- No free conductors or loose components that might interfere with the carriage.
- Pit is clean from any accumulation.

- In use light when required
- Door/Gate operator as per manufacturer instructions.
- Operating commands, key switch.





**HERCULES VERTICAL PLATFORM LIFT**  
**OWNER'S MANUAL**

**AmeriGlide**

© 2019 AmeriGlide, INC.

5110 Atlantic Avenue  
Raleigh, NC 27616