

- Purchase Order
 Request for Quote

1. GENERAL INFORMATION

1.1 Dealer Information

Dealer Name
Date (MM/DD/YY)
Address
City
Province/State
Postal Code
Email

1.3 Project

Purchase Order#
Contact
Phone
Ship To
City
Province/State
Postal Code

1.2 Shipping Information

Contact
Phone
Address
City
Province/State
Postal Code/ZIP

1.4 Type of Delivery

- Pick-up at Terminal Onsite Forklift
 Loading Dock Flatbed and Forklift
 Liftgate - Ground Delivery Pick-up AMG Facility

STANDARD INCLUSIONS

Each Hercules VPL Kit includes the following:

Model:	Hercules 750	Safety Features:	Obstruction sensor underpan limit switches emergency stop emergency lowering slip-resistant floor key lock controls brass safety nut automatic folding ramp
Dimension:	36W x 54"D x 42" H		
Lifting height:	64"		
Tower height:	92"		
Capacity:	750 lbs		
Speed:	9 fpm		
Color:	Gray (RAL 7047)		
Motor:	1 hp, 24VDC motor		
Power supply:	120v/ 20A (2 x 12v gel batteries)		



2. CUSTOM CONFIGURATION

QUICK SHIP MODELS

Quick Ship units are available on these models only.
These units will be available to ship in 24-48 hours.

- RESIDENTIAL 64**
 COMMERCIAL 64***

* See page 6 for details.

** Includes 2 Gates and 2 Call Stations.

STANDARD MODELS

- RESIDENTIAL
 COMMERCIAL

2.1 Travel Height

EXACT TRAVEL HEIGHT IN INCHES: _____

NOTE - MEASURE FROM
TOP LANDING TO FLOOR/
PIT BOTTOM

- 44" MAXIMUM LIFT HEIGHT (TOWER 72")
 64" MAXIMUM LIFT HEIGHT (TOWER 92")
 78" MAXIMUM LIFT HEIGHT (TOWER 108")
 98" MAXIMUM LIFT HEIGHT (TOWER 126")
 115" MAXIMUM LIFT HEIGHT (TOWER 158")
 130" MAXIMUM LIFT HEIGHT (TOWER 158")
 160" MAXIMUM LIFT HEIGHT (TOWER 190")

HERCULES 750

VERTICAL PLATFORM LIFT

2. PLATFORM CONFIGURATION CONTINUED

2.2 Application

- RESIDENTIAL
- COMMERCIAL

2.3 Unit Power

- AC - 120v / 20A (POWER TRANSFORMER)
- DC - 24v / 15A (TWO 12v BATTERIES)

2.4 Cabin Height

- 42" GUARD PANELS
- PLATFORM CANOPY
- ENCLOSED CABIN 80" HIGH

2.5 Color

- ATLAS GRAY (STANDARD)
- CUSTOM COLOR (RAL UNIVERSAL CHART)
- STAINLESS STEEL

2.6 Load Capacity

- 750 LBS CAPACITY (STANDARD)
- 1000 LBS CAPACITY

2.7 Cab Configuration (Check One)

Tower on LEFT

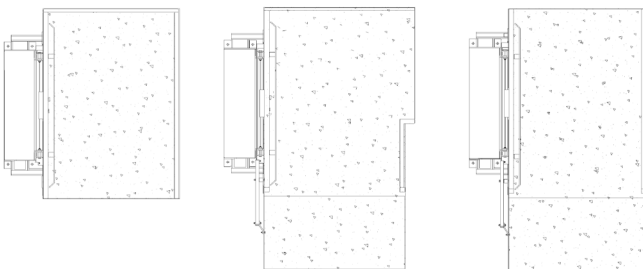

0°



90°



180°



Tower on RIGHT

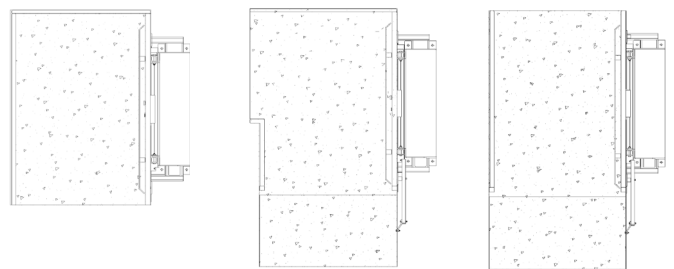

0°



90°



180°



2.8.1 Installation Type

- UNENCLOSED
- HOISTWAY / ENCLOSURE

2.8.2

- PIT MOUNTED
- CONCRETE SLAB

2.9 Wing Walls

- 64" TRAVEL (1625 mm)
- 78" TRAVEL (1981 mm)
- 98" TRAVEL (2489 mm)
- 115" TRAVEL (2921 mm)
- 130" TRAVEL (3302 mm)
- 160" TRAVEL (4064 mm)

2.10 Dimensions

- 34" X 54" (864 mm X 1372 mm)
- 34" X 60" (864 mm X 1524 mm)
- 36" X 54" (915 mm X 1372 mm)
- 36" X 60" (915 mm X 1524 mm)

- CUSTOM SIZE

CUSTOM SIZE IN INCHES: _____ WIDTH X _____ LENGTH
 * CHOOSE BETWEEN 30" to 44" WIDTH X 46" to 66" LENGTH*

HERCULES 750

VERTICAL PLATFORM LIFT

3. CALL STATIONS

3.1 Call Station Options (Please select your configuration)

CALL STATIONS (FLUSH MOUNTED, SURFACE MOUNTED, CALL POST, TOP GATE FRAME MOUNTED)

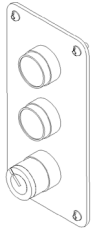

FLUSH MOUNTED

BOTTOM TOP

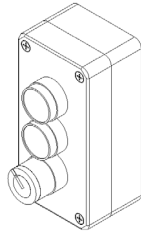

SURFACE MOUNTED

BOTTOM TOP



CALL POST

BOTTOM TOP

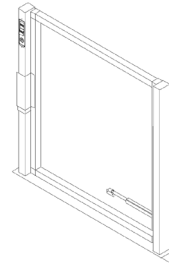

TOP GATE FRAME MOUNTED

TOP ONLY

3.2 Number of Stops

TWO STOPS

THREE STOPS

3.3 Controller Options

STANDARD ROCKER SWITCH

60MM CALL STATION BUTTON

60MM COP BUTTON

JOYSTICK

ADDITIONAL COP (ONE ON EACH SIDE)

LIGHTED BUTTONS (COP)

4. GATES AND DOORS

4.1 Lower Landing Entrance (Interlock Included)

4.1.1 Platform Gates

CHOOSE AN ORIENTATION:

* WHEN FACING THE GATE/DOOR FROM OUTSIDE OF THE PLATFORM *

LEFT RIGHT

34" OR 36" WIDTH X 42" HEIGHT

32", 38", 40", 42" WIDTH X 42" HEIGHT

ADDITIONAL OPTIONS

OPTIONAL LEXAN GATE UPGRADE

INTERLOCK ONLY

4.1.2 Doors

36" WOOD INTERIOR

36" FIRE RATED

36" EXTERIOR

36" POLYCARBONATE

38-42" WOOD INTERIOR

38-42" FIRE RATED

38-42" EXTERIOR

38-42" POLYCARBONATE

HERCULES 750

VERTICAL PLATFORM LIFT

4. GATES AND DOORS CONTINUED

4.2 Upper Landing Entrance (Interlock Included)

4.2.1 Top Gates

CHOOSE AN ORIENTATION:

* WHEN FACING THE GATE/DOOR FROM OUTSIDE OF THE PLATFORM *

LEFT
 RIGHT

- 34" OR 36" WIDTH X 42" HEIGHT
- 32", 38", 40", 42" WIDTH X 42" HEIGHT

ADDITIONAL OPTIONS

- OPTIONAL LEXAN GATE UPGRADE
- INTERLOCK ONLY

4.2.2 Doors

- 36" WOOD INTERIOR
- 36" FIRE RATED
- 36" EXTERIOR
- 36" POLYCARBONATE
- 38-42" WOOD INTERIOR
- 38-42" FIRE RATED
- 38-42" EXTERIOR
- 38-42" POLYCARBONATE

5. AUTOMATIC GATE AND DOOR OPENERS

	QUANTITY	TOTAL
<input type="radio"/> DOOR CLOSER (REQUIRED IF NO DOOR OPERATOR INSTALLED)		
<input type="radio"/> AUTOMATIC GATE OPERATOR (RESIDENTIAL ONLY)		
<input type="radio"/> AUTOMATIC DOOR OPENER (RESIDENTIAL)		
<input type="radio"/> AUTOMATIC DOOR OPENER (COMMERCIAL)		

6. ADDITIONAL OPTIONS

<input type="radio"/> GRAB RAIL (INCLUDED IN COMMERCIAL KIT)		
<input type="radio"/> ANTI-CORROSION KIT (FOR INSTALLATIONS NEAR POOLS, WATER)		
<input type="radio"/> FOLDING SEAT + HARDWARE (INSTALLATION NOT INCLUDED)		
<input type="radio"/> SUPPORT BACK BRACKETS (FIXED ONTO CONCRETE SLAB)		
<input type="radio"/> TRIANGLE SUPPORT BRACKETS (FIXED TO UPPER LANDING) - INCLUDED WITH 115" - 130" - 160" MODELS		
<input type="radio"/> HANDS-FREE PHONE		
<input type="radio"/> STATIONARY RAMP 40" x 36" x 3"		
<input type="radio"/> TOUCH-UP PAINT	QUANTITY	TOTAL

HERCULES 750

VERTICAL PLATFORM LIFT

7. HERCULES PORTABLE

- TRAVEL 44" - 36" X 54"
- TRAVEL 44" - 36" X 60"
- TRAVEL 64" - 36" X 54"
- TRAVEL 64" - 36" X 60"

INCLUDES: 2 PLATFORM GATES, 2 CALL STATIONS, GRAB RAIL, FOLDING RAMP

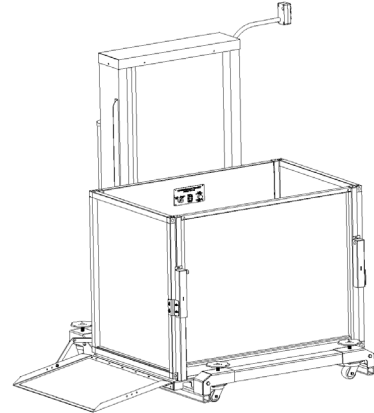

8. HERCULES ENCLOSURE

8.1 Travel

- TRAVEL 0" to 44"
- TRAVEL 0" to 64"
- TRAVEL 0" to 78"
- TRAVEL 0" to 98"
- TRAVEL 0" to 115"
- TRAVEL 0" to 130"
- TRAVEL 0" to 160"

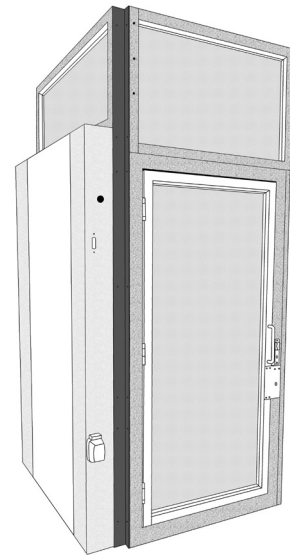

8.2 Options

- ROOF AND VENTILATION

<input type="radio"/> TINTED LEXAN (PER INCH OF TRAVEL)	QUANTITY	TOTAL

<input type="radio"/> GLASS ENCLOSURE (PER INCH OF TRAVEL)	QUANTITY	TOTAL